

## AI56 Acoustic imaging camera



The HIKMICRO AI56 acoustic imaging camera is a professional product for gas leak detection and partial discharge detection. With 64 Low-noise MEMS microphones and an adjustable bandwidth range from 0 kHz to 96 kHz, AI56 provides an easy and effective way to locate pressurized air leaks in industrial environments or detect partial discharge in electric systems. By adopting this lightweight and easy-to-use tool, you can discover potential safety risks, minimize troubleshooting, and save extra costs for equipment failures and downtime.

### Key Features

- 64 Low-noise MEMS Microphones, real-time sound source localization
- Real-time estimated leak rate, leak cost, and leak level for gas leak detection
- Partial discharge detection can identify corona, floating, surface, and particle discharges
- Analyzer acoustic software for analyzing images and export reports.
- 800 × 480 Resolution, 4.3'LCD Touch Screen
- Supports 8 acoustic palettes

## • Specification

<b>Acoustic</b>	
Number of Microphones	64
Acoustic Image Resolution	800 × 480
Bandwidth	0 kHz to 96 kHz, adjustable range MEMS sampling frequency: 192 kHz
Distance	0.3m~150m
Acoustic Image Palette	White Black, Black White, Rainbow, Fusion, Ironbow, Red Black, Rain, Blue Red
Camera FOV	50.2°× 35.4°
Sound Intensity Display	Peak Point
Acoustic Image Frame Rate	25 fps
Dynamic Range	Low Limit: <-15dB High Limit: >120dB
Leak Rate	>0.008 l/min @ 6 bar from 0.5 m (1.64 ft) >0.013 l/min @ 5 bar from 1 m (3.28 ft)
Discharge Detection	Automatic detection 50 / 60 Hz
Discharge Type	Corona Discharge, Particle Discharge, Floating Discharge, Surface Discharge
<b>Image Display</b>	
Display	800 × 480 Resolution, 4.3'LCD Touch Screen
Screen Brightness	Manual/Auto
Digital Zoom	1.0x to 16.0x continuous
<b>Data Storage and Communication</b>	
Storage Media	Removable 64 GB SD Card
Image Storage Capacity	20,000 images
Annotations	Voice note: max. 60 seconds; Text note: max. 255characters
Video Storage Capacity	60 hours
Video File Format	MP4
<b>General</b>	
Wi-Fi	802.11 b/g/n (2.4 GHz and 5 GHz)
Bluetooth	Bluetooth 4.1
USB Interface	USB Type-C
HDMI Interface	HDMI-D
Battery Operating Time	Approx. 3.5 hours
Battery Type	Dismountable and Rechargeable Li-ion Battery
Battery Charging Time	5 hours to full charge
Protection level	IP54
Power Supply	5V DC/2A (Charging via USB)
Drop Test Height	1.2 m (3.94 ft)
Safety	IEC 61010-1
EMC	EN 301 489-1,EN 301 489-17,EN IEC 61000-6-2,EN IEC 61000-6-4,EN 61326-1
Working Temperature Range	-20 °C to 50 °C (-4 °F to 122 °F)
Storage Temperature Range	-20 °C to 60 °C (-4 °F to 140 °F)

Relative Humidity	<95 % non-condensing
Weight	Approx. 940 g (2.07 lb)
Dimension	292.2 × 127 × 110.7 mm (11.50 × 5.00 × 4.36 in)
Tripod Mounting	UNC ¼"-20
Vibration	2g, IEC 60068-2-6
Shock	25 g, IEC 60068-2-27

## ▪ Available Model

HM-AP56-W/W-AI56

## ▪ Dimension

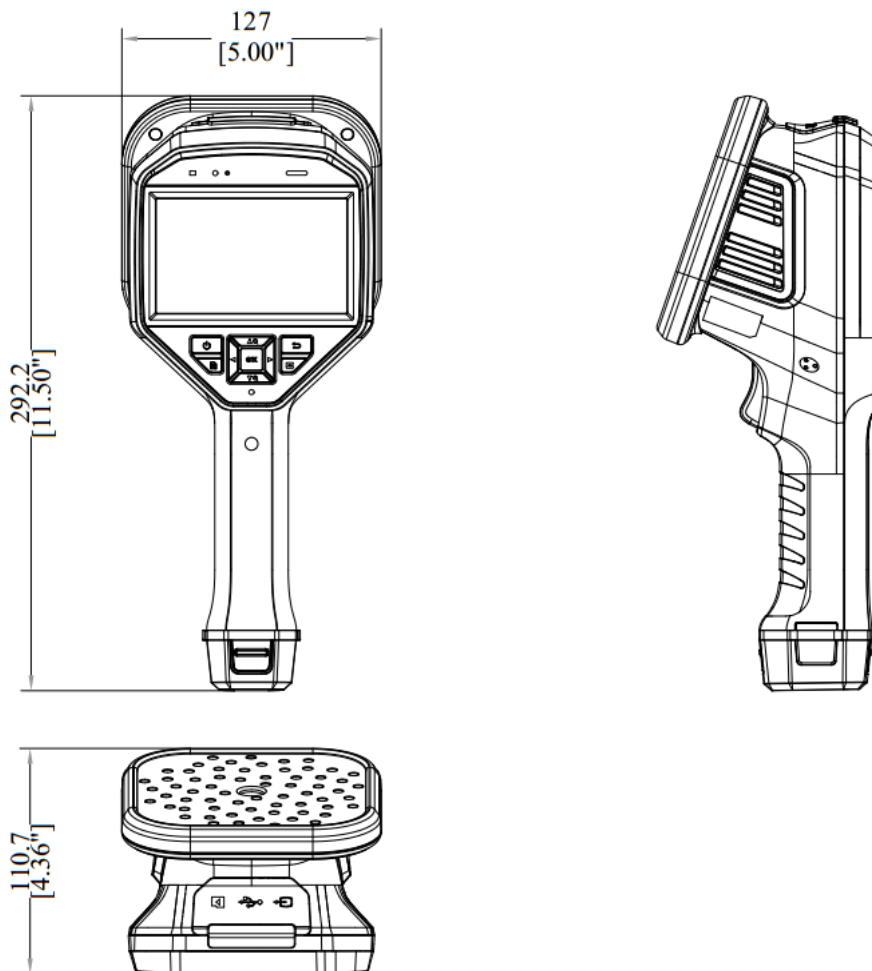

Unit: mm[Inch]

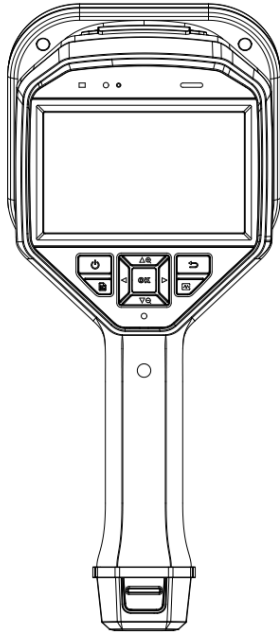

Acoustic Imaging Camera (X1)

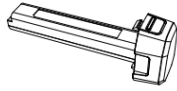

Battery (x2)

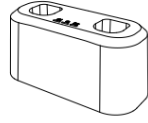

Charging Base (x1)

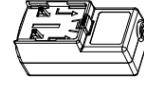

Power Adapter (x1)

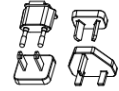

Adapter (x4)



Hand Strap (x1)



USB Cable (x1)



HDMI Cable (x1)



SD Card (X1)



MIC protective case (X1)

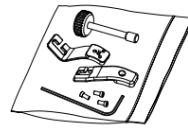

Accessories bag (x1)



Quick Start Guide (x1)

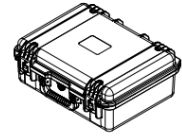

Carrying Case (x1)



ESPA ELEC

(+54) 11-6871-3274

INFO@ESPAELEC.COM.AR

WWW.ESPAELEC.COM.AR

